

Article number: 2310431061

Description: E+G Levelling elements
LX.30-SW17-M8X31

Measures

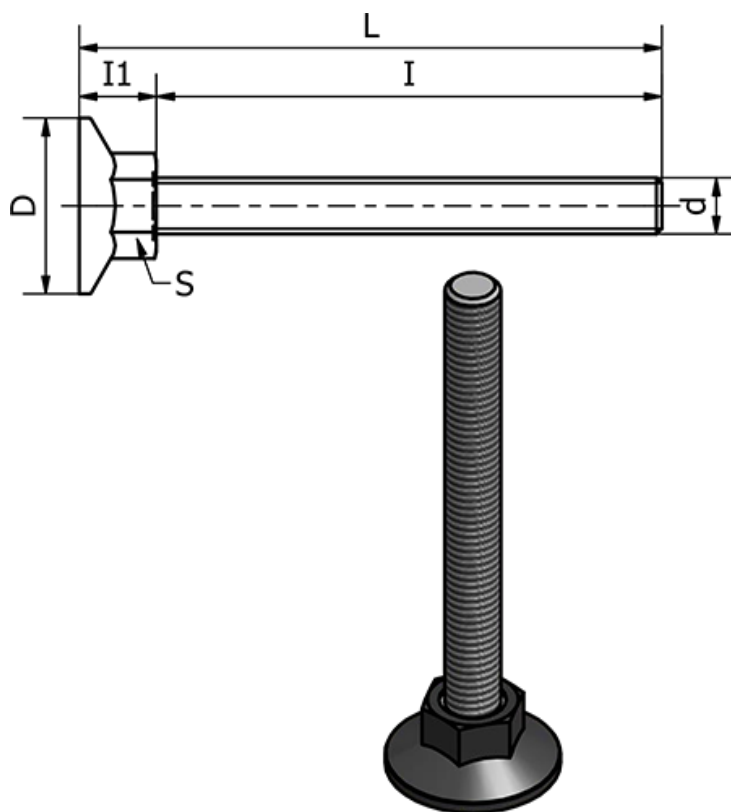

d = M8

D = 30

I = 31

I1 = 12

L = 43

S = 17

Static load in (N) = 2500

Type = Forzinket

Weight (g) = -